

Uitneembare paal Ø159 t.b.v ingraven in aardebaan

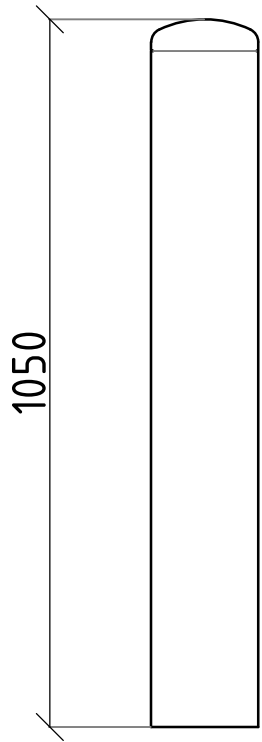

Afschermpaal:
Ø159x4,5x1050 mm.

Steekbus:
Buis Ø177,8x8 ndl
v.v. aangelaste buis Ø60

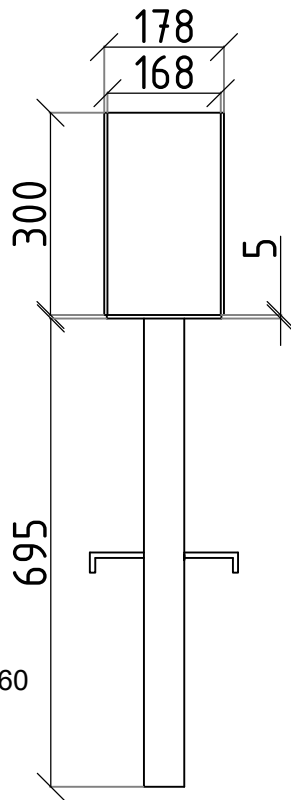

-Paal

- Steekbus

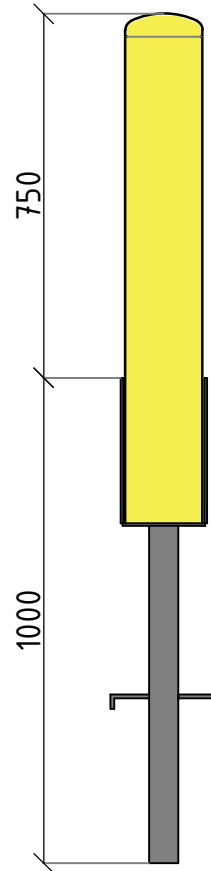

- Zonder sluiting

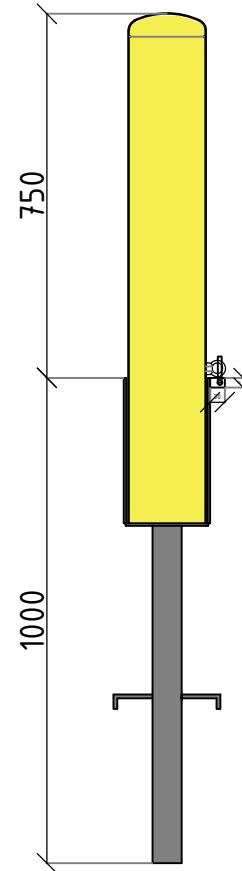

- Met sluiting

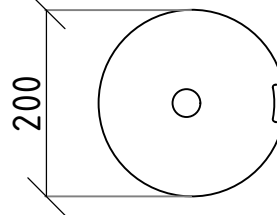

-Afdichtdeksel

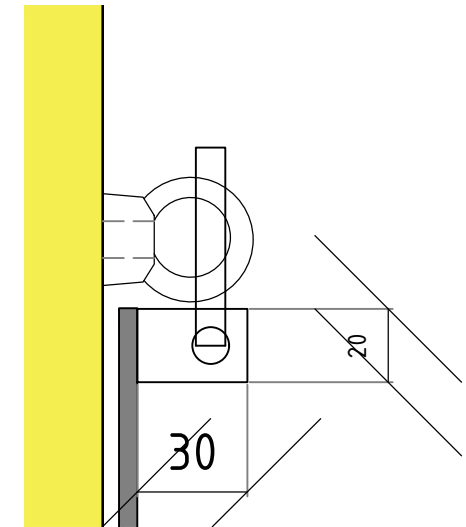
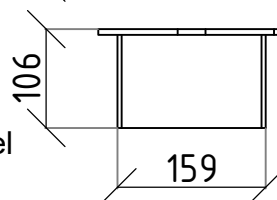

- Detail sluiting



Industrieweg 36
Postbus 66 - 7950 AB Staphorst
Tel. 0522-463050 - Fax 0522-463104
E-mail: info@wegbeveiligingstaphorst.nl
Internet: www.wegbeveiligingstaphorst.nl

Project	Uitneembare afschermpaal Ø159			A4
Tekening nr.	001			
Referentie				
Datum	31-05-2023	US	MM	
Datum gew.	-	Schaal		